

## ACCESSORIES

Caring for details



## MAKES THE DIFFERENCE

Cleaning your vehicle's surface is not enough for a perfect finish. For an exceptional finish, some details do make a huge difference. For that reason, ISTOBAL offers you a wide range of accessories designed to meet your every need, from the professional cleaning of the interior to the perfect tyre pumping, ensuring complete care and maintenance.





## Models

### 4AA10 / 4AA20

## General features

- > Robust
- > Reliable
- > Low maintenance

## Main features

- > Colour-customisable cover
- > Structure in AISI 304 stainless steel or painted in the colour of your choice
- > Wide range of payment systems: coins, tokens, proximity cards, combined method
- > External display with time and service counter
- > 4 polyester filter sleeves with external or automatic filter shaker
- > 5 or 10 m suction hose
- > IW Manager software for integrated control

## Technical features:

- > Turbine-type motor, 1.1 kW (single phase), 1.75 kW and 2.2 kW
- > Maximum suction: 3.000 mm H<sub>2</sub>O
- > Maximum flow rate: 330 m<sup>3</sup>/h
- > Filtering surface: 4 x 2,600 cm<sup>2</sup> = 10,400 cm<sup>2</sup>
- > Tank capacity: 36L

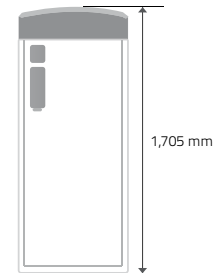
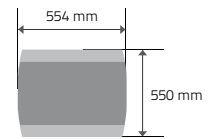

◀ Model 4AA10



Turbine detail

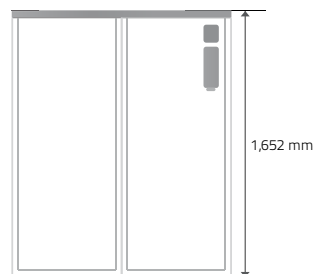
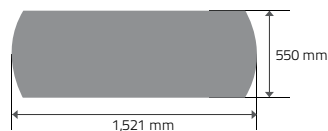

Model 4AA20 ▶



Turbine detail





## Model 4AA00

### General features

- > Simple
- > Effective
- > Functional

### Main features

- > AISI 304 stainless steel structure
- > 2 polyester filter sleeves with internal filter shaker
- > Token or coin basic payment system
- > Service counter
- > 5 or 10 m suction hose

### Technical features:

- > 2 by-pass motors, 1 kW (230V)
- > Maximum suction: 2.200 mm H<sub>2</sub>O
- > Maximum flow rate: 400 m<sup>3</sup>/h
- > Filtering surface: 2 x 2,600 cm<sup>2</sup> = 5,200 cm<sup>2</sup>
- > Tank capacity: 27 L

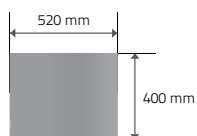

Model 4AA00 ▶



Motor detail

## MORE OPTIONS

### PAYMENT SYSTEMS

Three alternative payment systems: mechanical or electronic coin validator and proximity cards. All three include an external display indicating the service time remaining. Anti-vandal protection can be incorporated as an optional extra.



### AIR BLOWER OR FRAGRANCE

With an air blower to reach the smallest corners or with a nice fragrance.

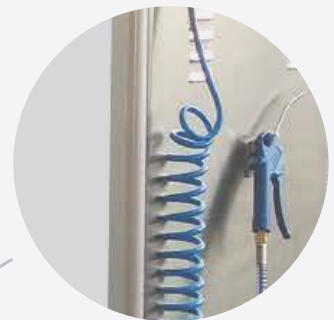

### IW MANAGER

New software designed for total remote and local management of all the units in your wash facility.



### SPRING HOLDER

The functional layout of the spring facilitates the use of the vacuum hose, preventing it from hanging on the ground and avoiding nozzle damage.



# SPRAYER

## Model 4QA00

### General features

- > Simple
- > Functional
- > Versatile

### Main features

- > AISI 304 stainless steel structure
- > Product selector
- > External viewer with countdown timer and service counter internal function
- > Decorative vinyl included
- > Two or four products

### Configurations:

- > **Exterior prewash**  
Flat nozzle for insect remover and rim degreaser products.
- > **Interior care**  
Spray nozzle for fragrances, and dashboard and tyre polish.

### Technical features:

- > Power: 2x55W or 4x55W
- > Flow rate: 0.22 L/min prewash or 0.08 L/min spraying
- > Capacity: 2 x 20 L / 4 x 10 L
- > Hose length: 3.5 m without boom arm / 8 m with boom arm
- > Voltage: 230 V

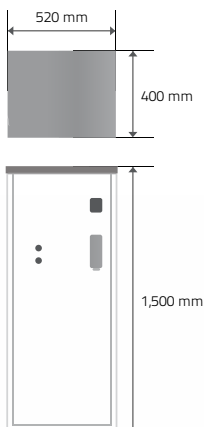

Model 4QA00 ▶



Spraying detail

### OPTIONS

- > Payment systems: token, mechanical or electronic
- > Boom arm
- > Internal heater
- > Products

**ISTOBAL**  
eSens



2 POSSIBLE  
CONFIGURATIONS

EXTERIOR  
PRE-WASH OR  
INTERIOR CARE





# TYRE PUMPS AND GAUGES

## Analogue Model 4VA01

### General features

- > Accurate
- > User-friendly
- > Design

### Features:

- > Stainless steel structure. AISI 304
- > Easy-to-read, accurate pressure indicator. Compliant with EC directives
- > Air only, or air and water
- > Air and water automatic hose reels or spiral hoses
- > Reinforced inflater adaptor

### Technical features:

- > Pressure: 0-10 bar/ 0-145 psi
- > Reading: 0.1 bar/2 psi
- > Hose length:  
8 m (hose reels) or  
7.5 m (spiral hoses)

## Digital Model 4VA11

### General features

- > Precision
- > Reliability
- > Simplicity

### Features:

- > Stainless steel structure. AISI 304
- > Clear and precise digital LCD pressure display. Compliant with EC directives
- > Sounder goes off when the set pressure is reached
- > Air and water automatic hose reels
- > Payment systems: coins, tokens, proximity cards, combined method
- > Dual-nozzle inflater adaptor

### Technical features:

- > Power supply voltage: 230 V
- > Pressure: 0.3-5,5 bar/ 4-80 psi
- > Reading accuracy: <0.08 bar / <1.16 psi
- > Hose length: 8 m

### OPTIONS

- > The payment system is optional

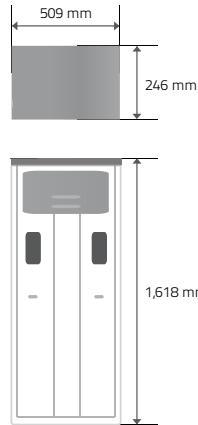

Model 4VA01 ▶

Benefits of having the right tyre pressure:

+ SAFETY  
- WEAR  
- FUEL CONSUMPTION



### OPTIONS

- > Possibility of including internal compressor, direct type or with tank.

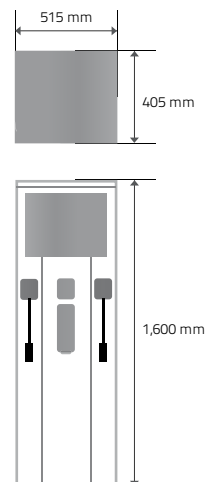

◀ Model 4VA11





# TYRE PUMPS AND GAUGES

## COMBO

### General features

- > Compact
- > Versatile
- > Practical

### Features:

- > Stainless steel structure. AISI 304
- > LED display with countdown timer; two possible configurations depending on function chosen
- > Function can be easily changed

### > Vacuum

Turbine and filtering system with high suction power and low noise level

### > Sprayer

Fragrances, dashboard, tyre polish, etc.  
Possibility of including up to 4 different products for the final cleaning of your vehicle.

### > Gauge

Air: Easy-to-use digital gauge with hose reel.  
Possibility of including an internal compressor.

- > **Screen washer:** Hose with reel with washer fluid service.



- > Do those little but important safety check-ups **while you vacuum** and clean your vehicle, like **pumping up the tyres** or **filling up the screen wash tank**.

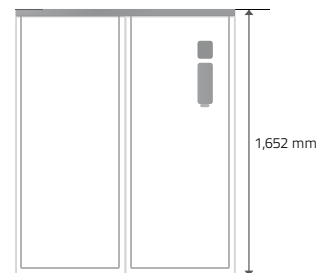
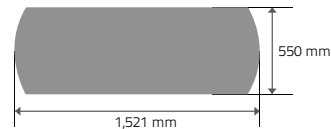

Model 4KA00

VACUUM,  
SPRAYER AND GAUGE,  
ALL IN ONE

Vacuum



Sprayer



Gauge



# MAT CLEANER

## Model 4LA00

### General features

- > Design
- > Effective
- > Functional

### Features:

- > AISI 304 stainless steel structure
- > Semi-automatic, cleans the dirtiest mat areas
- > Wash/dry selector
- > Can clean up to 80 cm wide mats
- > Payment system: coins or tokens
- > Service counter

### Technical features:

- > Blower: 1 kW
- > Usable brush width: 80 cm
- > Voltage: 380V

## Model 4LA11

### General features

- > Automatic
- > Clean
- > Robust

### Features:

- > Automatic conveyor system with self-cleaning cycle
- > 2 rollers for brushing and 2 special rollers for drying
- > Dry or wet (water) clean selector
- > Indicator with time and service counter

### Technical features:

- > Usable brush width: 54 cm
- > Voltage: 380V

### OPTIONS

- > A bacteria disinfectant can be added. Heater is optional

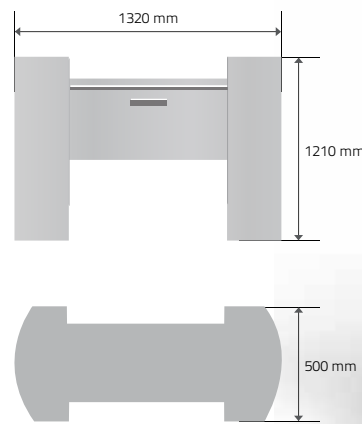

Model 4LA00 ▶



### OPTIONS

- > A bacteria disinfectant can be added

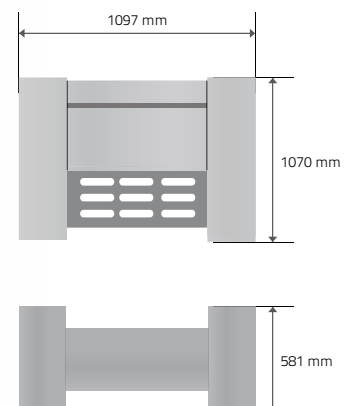



# OPTIONAL EXTRAS

## Dryer Model 4SA00

### Features:

- > Stainless steel structure AISI 304
- > Ergonomic drying nozzle
- > Service counter
- > Ø 50 mm coupling and hose

### Configurations:

- > Standalone at self-service
- > Built-in in Modulbox
- > Built-in in enclosure

### Technical features:

- > Power: 2x1.45 kW
- > Flow rate: 355 m<sup>3</sup>/h
- > Voltage: 230 V

### OPTIONS

- > Wall or post-mounted boom arm
- > Token or coin operated mechanical payment system or via connection to main payment terminal
- > Extended length for additional hose
- > Decorative vinyl

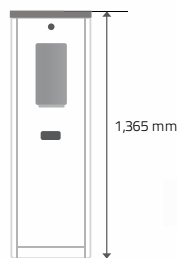
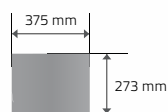

Model 4SA00 ▶

## Paper/cloth dispenser Model 4XA00

### Features:

- > AISI 304 stainless steel structure
- > No paper light indicator
- > Service counter

### Configurations:

- > Paper or cloth

### Technical features:

- > Power: 80 W or 150 W
- > Maximum roll width: 390 mm
- > Voltage: 230 V

### OPTIONS

- > Mechanical or electronic token payment system
- > Decorative vinyl

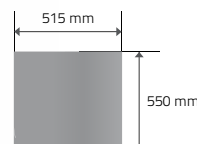

◀ Model 4XA00



**Mat beater  
Model 4049100**

**Features:**  
Galvanised steel grate with rust protection, and 60 L dust box with lock.



**Dust cloth drainer with sink  
Model 4380300**

**Features:**  
Stainless steel fairing AISI304 and water cascade



**Mat beater  
Model 4049000**

**Features:**  
Curved tube, 60 mm hotdip galvanised steel for rust protection.



**MORE OPTIONS**



> Sound and heat insulation



> Inflater adaptor



> Heater



> Compressors



> Product dosing

**Note:** ISTOBAL, S.A. reserves the right to introduce its products modifications designed to improve.





